

[pro]master®

FL190

[*Electronic*
Flash]

User Guide





INTRODUCTION

Thank you for your purchase of the ProMaster FL190 Electronic Flash

The ProMaster FL190 Electronic Flash is a feature-rich, high-output flash unit designed to use as your primary on-camera flash or as a master or slave unit in a wireless, multiple-flash system.

Before using your new ProMaster FL190 flash, please read this User Guide and your camera's instruction manual to familiarize yourself with the operation and features of your flash and the proper use with your camera.

FEATURES

Large Hi-Visibility LCD Panel makes it easy to see and set the functions of your flash.

Master & Slave Modes are compatible with the camera manufacturers' optical pulse wireless TTL systems and allow you to easily use the FL190 in a multiple flash setup.

High Power Flash. The FL190 features a guide number of 190'/58m at 100 iso.

Automatic / Manual Power Zoom provides flash coverage from 24 – 105mm (14mm when using built-in wide panel) either controlled by your camera in the automatic mode or set manually as you choose.

Full Support for ETTL/iTTL Functions including Exposure Compensation, Exposure Bracketing, Rear-curtain Sync, Exposure Lock, Aperture Imaging Flash Preview (Canon only), and more. (Subject to functions supported by your camera.)

Fast Recycle Time of only .1~5 seconds with AA batteries.

External Power Pack Support. The FL190 includes a socket for an external power pack for greater flash capacity and faster recycling.

PC Sync Port allows the use of wired PC cords to trigger the flash.

Sound Prompt System provides audible alerts for more convenience when shooting, especially in remote situations. (Default setting is OFF. Enable this function in the custom settings menu.)

Power Save Mode conserves your battery power. Duration can be set in the Custom Settings Menu.

Function Memory automatically saves your last flash setup when you manually power off the flash or the flash goes to sleep in the power save mode.

Advanced options setting allows you to set a variety of default modes for your flash to match your shooting preferences.

PARTS IDENTIFICATION

- 1 Flash head
- 2 Wireless sensor
- 3 AF assist lamp
- 4 Mounting foot
- 5 Locking pin
- 6 Catch light reflector panel (retracted)
- 7 Wide panel (retracted)
- 8 Contact cover
- 9 Flash foot contacts
- 10 External power source socket
- 11 PC Terminal
- 12 ¼-20 bracket mounting hole
- 13 Mini flash stand storage pocket
- 14 Mini flash stand
- 15 Mini flash stand shoe

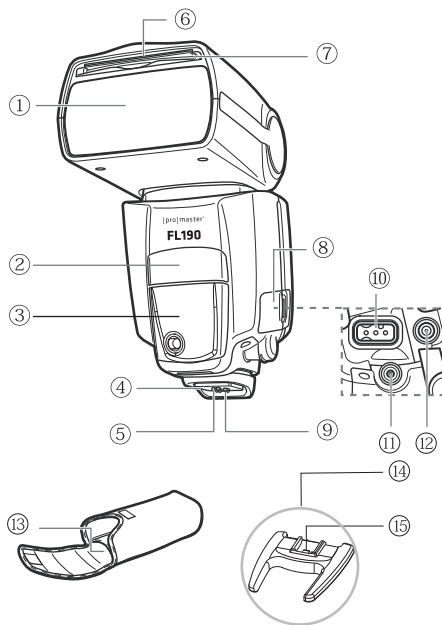

- 16 LCD panel
- 17 Flash mode button
- 18 LCD panel illumination/custom function settings button
- 19 Pilot lamp/test firing/wireless slave power on button
- 20 Flash exposure confirmation light
- 21 Mounting foot's lock lever
- 22 Lock-release button
- 23 Dust-and water-resistant shield
- 24 Bounce angle scale
- 25 Bounce lock release button
- 26 Rear-curtain sync shortcut (Canon) | ISO /Aperture value button / Group(A B C) button (Nikon)
- 27 Battery compartment cover
- 28 Battery compartment lock
- 29 ZOOM button/wireless selector/ wireless set button
- 30 Power switch
- 31 Selection dial
- 32 Select/set button

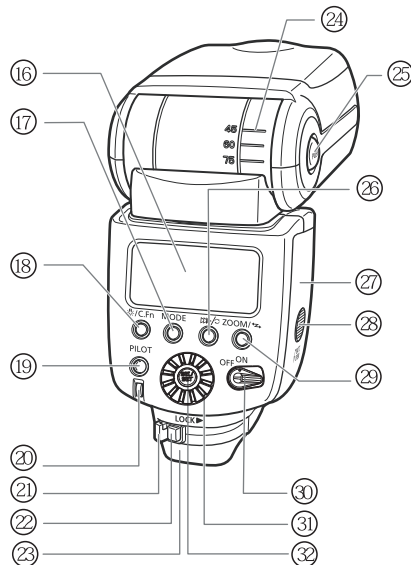

LCD PANEL

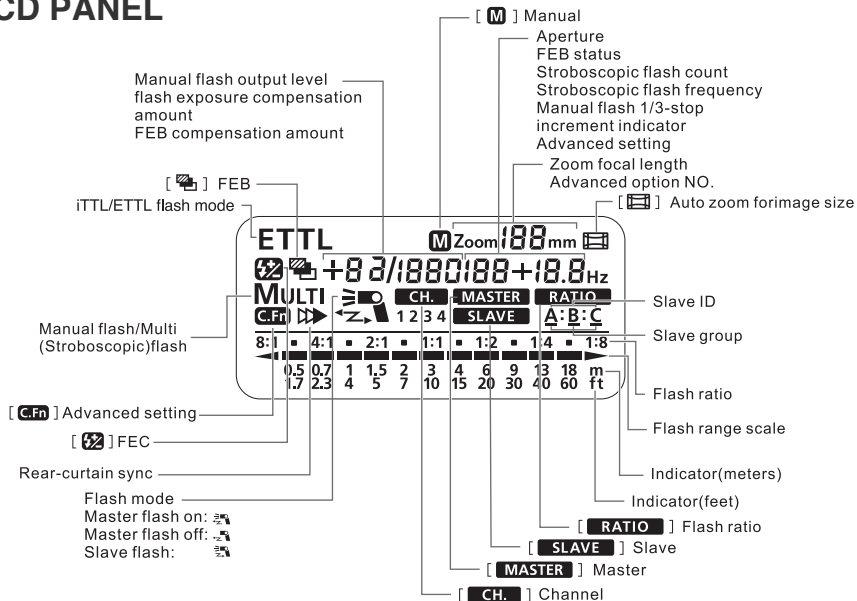

OPERATIONS

Installing the Batteries

Use your thumb to press the battery compartment lock lever, then slide it as shown by the arrow ① to open the cover.

Install the batteries. Make sure the + and - battery contacts are properly oriented as shown by the diagram inside the battery compartment.

Close the battery compartment cover and slide it as shown by the arrow. When the cover clicks in place, it will be locked.

Be sure to use fresh AA batteries. For best performance, avoid mixing battery brands or types.

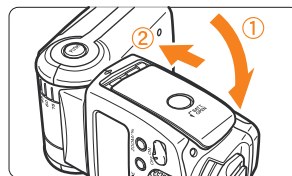
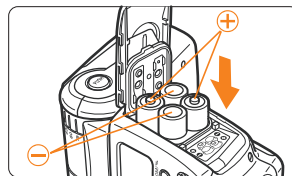
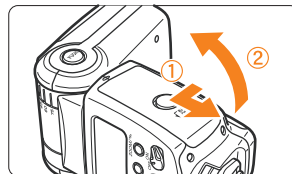

Attaching to the Camera

To attach the flash to your camera, slip the flash's mounting foot all the way into the camera's hot shoe.

Secure the flash by sliding the lock lever on the mounting foot to the right. When the lock lever clicks into place, it will be locked.

To detach the flash, press the lock-release button, slide the lock lever to the left and remove the flash from the camera hot shoe.

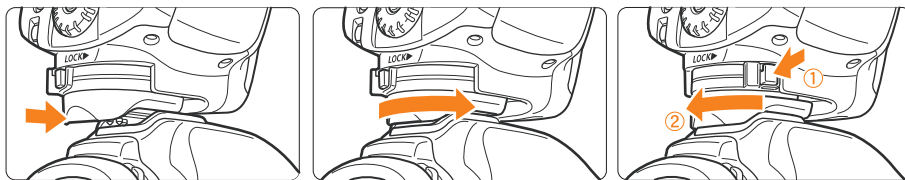

Basic Functions

Power-on and Power-off the flash using the OFF/ON power switch (30). When the PILOT light (19) turns red the flash is charged and ready for use. If the LCD screen blinks LO, there is not sufficient battery capacity to power your flash. Replace the batteries with fresh AA batteries.

M Mode allows you to set the flash output from 1/128 power to 1/1 full power in 1/3 stop increments. In the M Mode, use a hand-held flash meter to determine the required flash output to obtain a correct flash exposure. To select the output, press the MODE button until **M** is displayed. Press the Select/Set button and rotate the Selection Dial until the desired output is shown on the LCD. Press the Select/Set button to set the output level.

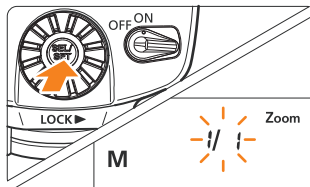
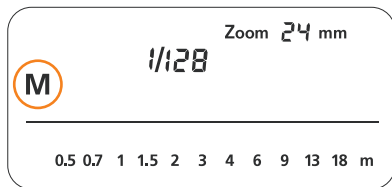

Multi Mode is a stroboscopic flash mode where a rapid series of flashes is fired. It can be used to capture multiple images of a moving subject in a single photograph. To achieve this effect your camera's shutter must remain open. You can set the firing frequency (number of flashes per second expressed as Hz), the number of flashes, and the flash output. To set, press the MODE button until Multi is displayed on the LCD.

Press the select button and use the select dial to adjust flash output, the number of flashes and firing frequency. Once these are set, press the Select/Set button to confirm the setting. The output may be adjusted to 1/128-1/64-1/32-1/16-1/8-1/4, flash frequency may be set from 1~100.

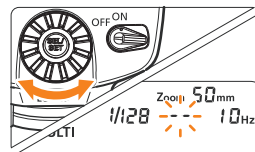
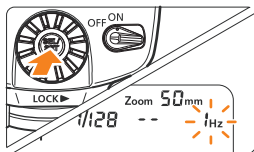
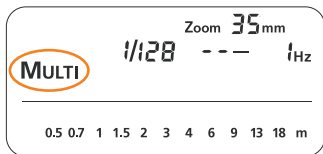

Note: The operation of high frequency flash may be impacted by the state of your batteries not allowing the flash to recycle fast enough. If you experience problems, reduce the flash frequency or replace your batteries with a fresh set.

ETTL Mode (Flash for Canon)

In the ETTL mode the FL190 supports Flash Exposure Compensation (FEC), Flash Exposure Bracketing (FEB), Rear (Second) Curtain Sync, and Flash Exposure Lock. Refer to your camera's instruction manual for proper operation of these features.

i-TTL Mode (Flash for Nikon)

In the i-TTL mode the FL190 supports Flash Exposure Compensation (FEC), Flash Exposure Bracketing (FEB), Rear (Second) Curtain Sync, and Flash Exposure Compensation (FEV). Refer to your camera's instruction manual for proper operation of these features.

Test Flash

In any mode, you can press the PILOT button to fire the flash. When testing the flash, the flash will flash at the chosen output power setting.

Setting the ZOOM Coverage

When attached to the camera and the flash head is in the 90° position, the position of the flash zoom head will be set automatically to match the zoom position of your lens.

To set the zoom position manually, press the ZOOM button. The Zoom indicator on the LCD will flash. Rotate the Select Dial until the desired zoom coverage is displayed on the LCD. Press the Select/Set button to confirm the setting.

Note: Using the built-in wide angle panel when the zoom coverage is set to 24mm will give you flash coverage for 14mm.

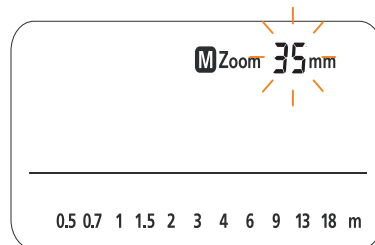
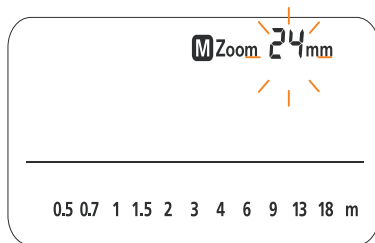

C.Fn – Custom Function for Canon Model

You can customize the features of the FL190 to suit your shooting preferences. You do this with Custom Functions Setting.

Custom Function No.	Function	Setting No.	Settings & Description
C.Fn-00	Distance indicator display	0	Meters(m)
		1	Feet(ft)
C.Fn-01	Auto power off	0	Enabled
		1	Disabled
C.Fn-02	Modeling flash	0	Enabled(Depth-of-field preview button)
		1	Enabled(Test firing button)
		2	Enabled(with both buttons)
		3	Disabled
C.Fn-03	FEB auto cancel	0	Enabled
		1	Disabled
C.Fn-04	FEB sequence	0	0→→→+
		1	→→0→+
C.Fn-05	Flash metering mode	0	E-TTL II/E-TTL
		1	TTL
		2	External metering: Auto
		3	External metering: Manual
C.Fn-06	Quickflash with continuous shot	0	Disabled
		1	Enabled
C.Fn-07	Test firing with autoflash	0	1/32
		1	Full output

C.Fn-08	AF-assist beam firing	0	Enabled
		1	Disabled
C.Fn-09	Auto zoom for sensor size	0	Enabled
		1	Disabled
C.Fn-10	Slave auto power off timer	0	60 minutes
		1	10 minutes
C.Fn-11	Slave auto power off cancel	0	Within 8 hours
		1	Within 1 hour
C.Fn-12	Flash recycle with external power source	0	Flash and external power
		1	External power source
C.Fn-13	Flash exposure metering setting	0	Speedlite button and dial
		1	Speedlite dial only
C.Fn-14	Auto power off (Sleep mode)	2	2 minutes(DEFAULT)
		5	5 minutes
		10	10 minutes
		30	30 minutes
		1H	1 hour
		2H	2 hours
		3H	3 hours
		4H	4 hours
		5H	5 hours
C.Fn-15	Sound control setting	0	OFF
		1	ON
C.Fn-16	Clearly defined function setting	0	NO
		1	Customize the default recovery setting

C.Fn – Custom Function for Nikon Model

You can customize the features of the FL190 to suit your shooting preferences. You do this with Custom Functions Setting.

Custom Function No.	Function	Setting No.	Settings & Description
C.Fn-00	Distance indicator display	0	Meters(m)
		1	Feet(ft)
C.Fn-01	Repeat the main flash unit flash mode	0	Disabled
		1	Enabled
C.Fn-02	Flash compensation under auto flash	0	compensation in 1/3 EV
		1	compensation in 1 EV
C.Fn-03	Enable or disable the power zoom function	0	Enabled
		1	Disabled
C.Fn-04	Manually set the zoom position when the built-in wide panel damaged	0	Enabled
		1	Disabled
C.Fn-05	Analog Lighting	0	Enabled camera analog lighting
		1	Enabled flash analog lighting
		2	Enabled flash&camera analog lighting
		3	Disabled all
C.Fn-06	Quickflash with continuous	0	Disabled
		1	Enabled
C.Fn-07	Test the flash output level under i-TTL mode	0	1/128
		1	1/32
		2	Full output

C.Fn-08	AF assist illuminator / flash function canceled	0	Enabled AF assist illuminator / flash function
		1	Cancel AF assist illuminator, Enabled flash function
		2	Enabled AF assist illuminator ,cancel flash function
C.Fn-09	Power off auto	0	Enabled
		1	Disabled
C.Fn-10	Slave auto power off timer	0	60 minutes
		1	10 minutes
C.Fn-11	Slave auto power off cancel	0	Within 8 hours
		1	Within 1 hour
C.Fn-12	Flash recycle with external power source	0	Flash and external power
		1	External power source
C.Fn-13	Flash exposure metering setting	0	Speedlite button and dial
		1	Speedlite dial only
C.Fn-14	Auto power off (Sleep mode)	A	auto(DEFAULT)
		2	2 minutes
		5	5 minutes
		10	10 minutes
		30	30 minutes
		1H	1 hour
		2H	2 hours
		3H	3 hours
		4H	4 hours
		5H	5 hours
C.Fn-15	Sound control setting	0	OFF
		1	ON
C.Fn-16	Clearly defined function setting	0	NO
		1	Customize the default recovery setting

To set Custom Functions, press and hold the C, Fn button until the Custom Function setting menu appears on the LCD. Use the Select Dial until the Fn number corresponds to the Custom Function you would like to set. Press the Select/Set button. The setting number will flash. Rotate the Select Dial until the desired setting number appears. Press the Select/Set button to confirm your choice.

Sound Prompt

If the Sound Prompt function is enabled, the FL190 will beep with a different sound pattern indicating its current status. The Sound Prompt factory default is off. The meaning of the sounds are in the following table:

Sound	Meaning	Operation
Beep Twice	The flash has been turned on and is ready for normal operation.	Normal
Beep Three Times	The flash is charging.	Wait for the charging to be complete.
Beep Three Times Twice	Possible under exposure	Adjust the exposure compensation or change the shooting conditions.
Beep Beep Beep	Possible over exposure	Adjust exposure setting or shooting condition.
Quick Continuous Beeps	Low battery power	Please replace the batteries.
Long Beep	The flash is fully charged and ready to fire.	Normal

Wireless Flash

In the Master flash mode, the FL190 will transmit an Optical Pulse signal to other slave flashes with the same system (FL 190 for Canon will control other FL190's for Canon or other Canon brand flashes. FL190 for Nikon will control other FL190's for Nikon or other Nikon brand flashes).

When set as a slave, the FL190 can receive signals from models of the same brand. (FL190 or Canon Brand for FL190 for Canon, FL190 or Nikon Brand for FL190 for Nikon.)

Set the Flash to Master Mode

To set the FL190 to the Master Mode, press the ZOOM button for three seconds. The remote flash icon will appear and OFF flashes on the LCD. Use the select dial to choose Master, then press the Select/Set button to confirm. To set the channel or power ratio, press the ZOOM button until the desired option flashes. Rotate the Select Dial to choose the desired option then press the Select/Set button to confirm the setting.

Set the Flash to Slave Mode

To set the FL190 to the Master Mode, press the ZOOM button for three seconds. The remote flash icon will appear and OFF flashes on the LCD. Use the select dial to choose Slave, then press the Select/Set button to confirm. To select the channel or slave group, press the ZOOM button until the item you wish to adjust flashes. Use the Selection Dial to adjust the setting, then press the Select/Set button to confirm the setting.

Multi-Flash Wireless Lighting Configurations

You can create two or three slave unit groups for multi-directional shooting. The manual flash output and stroboscopic functions are set by the master flash.

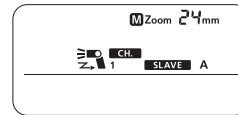
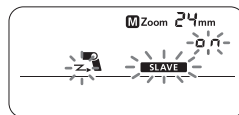
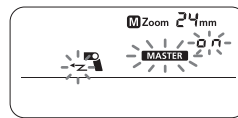
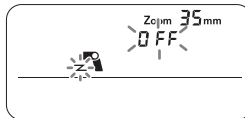

Wireless flash with two slave groups

1. Set the communication channel on each flash to the same channel: 1, 2, 3 or 4
2. Set the flash in each slave group to A or B
3. Set the communication channel of the master flash to the same channel as the slaves. To set the flash output of each group, press the ZOOM button until **RATIO** flashes on the LCD. Rotate the Select Dial until **A:B** flashes. Press the Select/Set button to confirm the setting. Rotate the Select Dial to choose the output of group A vs group B. You are ready to shoot.

Wireless flash with three slave groups

1. Set the communication channel on each flash to the same channel: 1, 2, 3 or 4
2. Set the flash in each slave group to A, B, or C
3. Set the communication channel of the master flash to the same channel as the slaves. To set the flash output of each group, press the ZOOM button until RATIO flashes on the LCD. Rotate the Select Dial until A:B C flashes. Press the Select/Set button to confirm the setting. Rotate the Select Dial to choose the output of group A vs group B. The output of group C can be adjusted by pressing the Select/Set button until C flashes. Then rotate the Select Dial to adjust the output of group C \pm 3 stops in 1/3 stop increments.

Press the PILOT button to test the flash communication between groups.

Important Notes

- If the Master flash is set to RATIO A:B group C will not flash.
- If the Ratio A:B is off, all groups will be controlled as a single group.
- Wireless operation is accomplished by optical pulse. The distance and direction of slave flashes from the master, as well as the ambient lighting conditions, can impact the ability of the master flash to properly control the slave flashes.

Multi-Flash Wireless Lighting Configurations

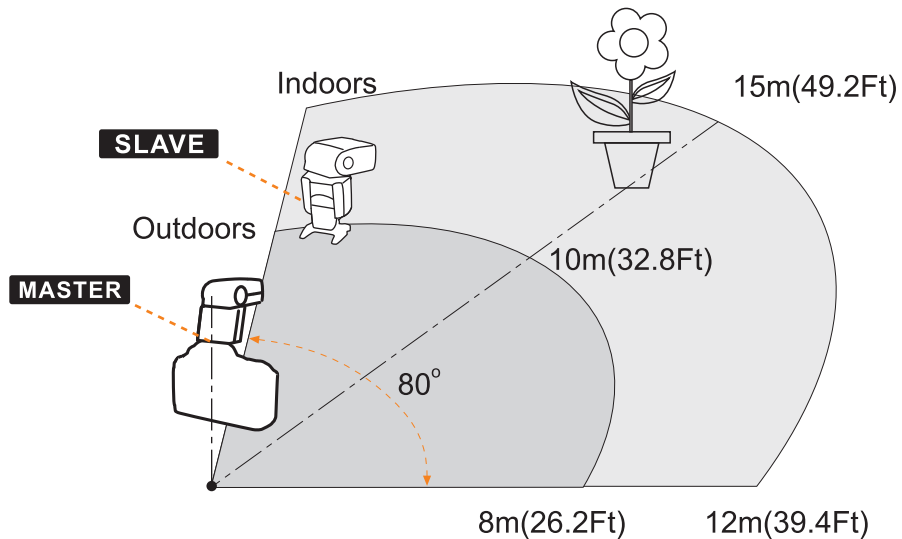

S1/S2 Mode

Press the ZOOM button for three seconds. The remote flash icon will appear and OFF flashes on the LCD. Rotate the Select Dial until S1 or S2 flashes. Choose the desired mode and press the Select/Set button to confirm the setting.

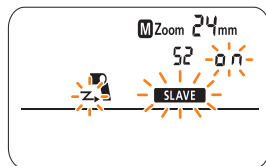
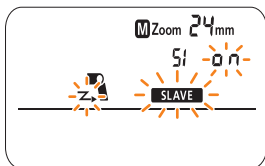
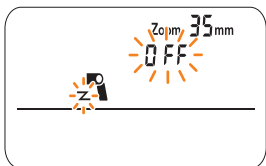

S1 Mode: When the flash is in S1 mode, it will fire in sync with the first flash from the master flash. To use this mode correctly, the master flash should be set to manual and without using any red-eye reduction mode.

S2 Mode: This is the “pre-flash cancel mode”. This mode will ignore the pre-flash used for focusing and red-eye reduction in the TTL flash mode using the cameras built in flash. Your particular camera may not support this function.

FEL Lock (Canon)

To use this function, center your subject in the center of the viewfinder of your camera. Press the AEL button on the camera (*), the flash will pre-flash and the camera will calculate the appropriate flash output data. Now compose your photo as desired and shoot the picture. (The function is only available when it is supported by your camera. For more information refer to your camera instructions.)

FV Lock (Nikon)

Set the AE-L/AF-L function as FV Lock on the camera before using this function. Center your subject in the center of the viewfinder of your camera and then press the AE-L key or AF-L key. The flash will pre-flash and the camera will calculate the appropriate flash output data. Now compose your photo as desired and shoot the picture. (The function is only available when it is supported by your camera. For more information refer to your camera instructions.)

Creating a Catchlight

With the built-in catchlight panel, you can create a catchlight in the subject's eyes to add life to the facial expression.

Built-In Wide-Angle Diffuser

The built-in wide angle diffuser will extend the coverage angle of your flash as well as providing a softer more pleasing light.

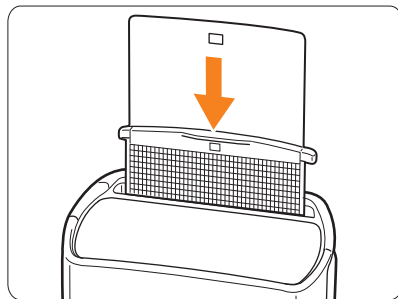
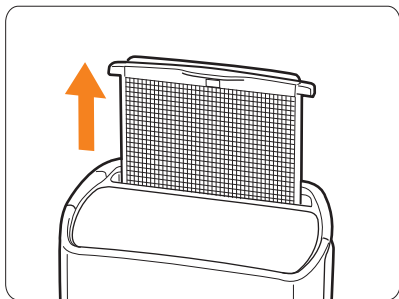

Pull out the built-in wide angle diffuser & catchlight panel assembly. To use the wide angle diffuser, fold down to cover the flash lens and push the catchlight reflector back into the flash housing. To use the catchlight panel, pull out the assembly and push the diffusion panel back into the flash housing.

Using an External Power Supply

Your FL190 flash will allow you to use an external power source to get a faster recycle time and more exposures without the need to change batteries. The external power socket on the FL190 is compatible with a Canon type connector.

To use an external power source, fresh batteries must be installed in the flash. You can use Custom Function 12 (C.Fn-12) to select the external power source mode that best suits your shooting needs.

Settings Memory and Factory Reset

When you power off the FL190, it will remember your last used settings. This is helpful when you are set up for a specific shooting situation and the flash goes into the auto power off mode or you turn the flash off during idle periods to conserve battery use. Don't forget to reset your flash to the normal setting when you are done with your shoot. Alternately, you can reset the FL190 to the factory default settings by opening the battery compartment door when the flash is ON. This will interrupt power to the flash and when the battery door is closed, the flash will be reset to the factory default settings.

Flash Exposure Compensation

You can use the exposure compensation function of the camera to compensate flash output to get your desired results. You can also adjust the flash brightness ± 6 in 1/3 increments by pressing the Select/Set button in the ETTL/iTTL mode and rotating the Select Dial to select the desired adjustment. Press the Select/Set button to confirm the setting.

Rear Curtain Sync

You can use slow shutter speeds to produce motion effects using the rear-curtain sync function. (For rear curtain sync settings, refer to your camera instructions.) You can turn on or turn off the rear curtain sync by pressing the rear curtain sync key on the flash.

Note: When flash is used as slave unit, the rear curtain sync function cannot be set on the flash.

Flash Exposure Bracketing - FEB

The Flash Exposure Bracketing function is set on your camera. Refer to your camera instructions with your camera model. When the FEB mode is set, exposure compensation will be made automatically in sequence, for example “normal-under-over”.

Note: For the FEB mode, set the camera's drive mode to single shooting and be sure the flash is ready before shooting.

Auto Zoom for Image Size (Canon)

EOS DIGITAL cameras have one of three image sizes. The lens' effective focal length will differ depending on the camera's image size. The flash automatically recognizes the EOS DIGITAL camera's image size and automatically sets the flash coverage for lens focal lengths from 24mm to 105mm. When the flash is attached to a compatible camera,  will appear on the flash's LCD panel.

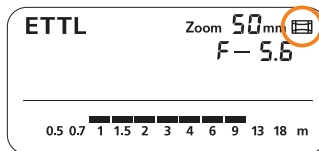

Type:	On-Camera Electronic Flash
Guide No.:	190' / 58m (at 105mm focal length, 100 ISO)
Flash coverage:	24 - 105mm (14mm with wide panel) Auto/Manual Zoom
Exposure control system:	iTTL/ETTL, Manual flash, frequency flash
Locking Bounce Swivel	
Flash Head:	Bounce Position - 0°, 45°, 60°, 75°, 90° Swivel - 0° - 180° Left and Right
Flash Exposure Compensation:	Manual, FEB: ±6 stops in 1/3-stop increments
Multi flash:	1 - 199 Hz
Rear-curtain Sync:	Yes
Flash Exposure Confirmation:	Yes
Recycling time:	Approx. 0.1 - 5 sec.
Wireless TTL Flash:	Optical pulse 4 Channels, 3 Groups
Custom Flash Modes:	17 user selectable settings
Power Source:	Four size-AA alkaline batteries or lithium batteries Optional HV power supply
Power Save Mode:	User selectable duration
Dimensions:	7 ½ x 2 15/16 x 1 15/16" / 190 x 75 x 49 mm
Weight:	13.1 oz. / 370 g

Flash Index of different focal length range (ISO 100, in meters /feet)

Flash output	Flash coverage (mm)							
	14	24	28	35	50	70	80	105
1/1	15/49.2	28/91.9	30/98.4	36/118.1	42/137.8	50/164	53/173.9	58/190.3
1/2	10.6/34.8	19.8/65	21.2/69.6	25.5/83.7	29.7/97.4	35.4/116.1	37.5/123	41/134.5
1/4	7.5/24.6	14/45.9	15/49.2	18/59.1	21/68.9	25/82	26.5/86.9	29/95.1
1/2	5.3/17.4	9.9/32.5	10.6/34.8	12.7/41.7	14.8/48.6	17.7/58.1	18.7/61.4	20.5/67.3
1/16	3.8/12.5	7/23	7.5/24.6	9/29.5	10.5/34.4	12.5/41	13.3/43.6	14.5/47.6
1/32	2.7/8.9	4.9/16.1	5.3/17.4	6.4/21	7.4/24.3	8.8/28.9	9.4/30.8	10.3/33.8
1/64	1.9/6.2	3.5/11.5	3.8/12.5	4.5/14.8	5.3/17.4	6.3/20.7	6.6/21.7	7.3/24
1/128	1.3/4.3	2.5/8.2	2.7/8.9	3.2/10.5	3.7/12.1	4.4/14.4	4.7/15.4	5.1/16.7

TROUBLESHOOTING

The flash does not fire.

1. The batteries are installed in the wrong orientation. Install the batteries in the correct orientation.
2. The flash's batteries are exhausted: If the flash recycling time takes 30 seconds or longer, replace the batteries.
3. The flash is not attached securely to the camera. Attach the flash's mounting foot securely to the camera.
4. The electrical contacts of the flash and camera are dirty. Clean the contacts.

The slave unit does not fire.

1. The slave's wireless mode is not set to <SLAVE>. Set it to <SLAVE>.
2. The slave unit(s) is not positioned properly. Place the slave unit within the master unit's transmission range. Point the slave unit's sensor toward the master unit.

The power turns off by itself.

1. Auto power off (sleep) is in effect. Press the shutter button halfway or press the test fire button.

The edges or bottom of the picture looks dark.

1. When you set the flash coverage manually, the setting has a higher number than the lens focal length, resulting in dark edges. Set the flash coverage that is a lower number than the lens focal length or set it to auto zoom.
2. If only the bottom of the picture looks dark, you were too close to the subject. If the subject is closer than 2 m/6.6 ft., tilt the flash head downward by 7° (bounce flash).

The flash exposure is underexposed or overexposed.

1. There was a highly reflective object (glass window, etc.) in the picture. Use FE lock.
2. The subject looks very dark or very bright. Set flash exposure compensation. For a dark subject, set a decreased flash exposure. And for a bright subject, set an increased flash exposure.

IMPORTANT INFORMATION

- Do not fire flashes from a short distance directly into the eyes of people or animals. This can cause damage to the retina and may even lead to blindness.
- Always use batteries of the same type, brand, and age. Always replace all 4 batteries at the same time. Do not combine different types, brands, old, or new batteries. This could cause the batteries to overheat, leak, or explode.

- While Ni-MH or Lithium AA batteries may be used in your flash, using AA batteries other than alkaline type may cause improper battery contact due to the irregular shape of the battery contacts.
- Install the batteries in proper orientation as indicated in the battery chamber. Installing the batteries incorrectly could cause the batteries to overheat, leak, or explode.
- If you change the batteries after a period of sustained continuous firing of the flash, the batteries may become warm or hot. This is normal, however you should take care when handling the batteries.
- Always switch off the flash before changing the batteries.
- Do not attempt to open the flash because the electronic circuit contains high voltage.
- If the flashgun is badly damaged and internal components are exposed, remove the batteries from the flash. Contact customer service. Never try to repair the flashgun by yourself.
- This product is not water-resistant. Keep it away from rain, snow, and high humidity areas.

- Do not clean the flash with agents containing corrosive or flammable substances. Also, do not store or use the flash in flammable conditions.
- To avoid overheating and degrading the flash tube, do not fire more than 20 continuous flashes in rapid sequence. After 20 continuous flashes, allow a rest period of at least 10 minutes. If you fire more than 20 continuous flashes in rapid sequence and then fire more flashes in short intervals, the internal overheating prevention function may be activated and the recycling time will increase to about 8 to 20 seconds. If this occurs, allow a rest time of about 15 minutes and the flash recycling time will return to normal..
- If you use a commercially available sync cord to connect the camera to the flashe's PC terminal, be sure to set the flash zoom manually for proper coverage.
- In the Multi Mode (stroboscopic flash), the camera's shutter should remain open until the flash completes the number of flashes that have been set. The shutter speed to set on the camera is calculated by $\text{Number of flashes} \div \text{Firing frequency} = \text{Shutter speed}$. For example, if the number of flashes is 10 and the firing frequency is 5 Hz, the shutter speed should be at least 2 seconds.

KEEP IN TOUCH

For more information, tutorials, industry news and tips & tricks, make sure to visit us at promaster.com, follow our feeds on Twitter @promasterphoto, and subscribe to our YouTube Channel username ProMasterChannel.

ONE YEAR UNCONDITIONAL GUARANTEE

If for any reason, this ProMaster product fails within ONE YEAR of the date of purchase, return this product to your ProMaster dealer and it will be exchanged for you at no charge.

ProMaster products are guaranteed for ONE FULL YEAR against defects in workmanship and materials. If at any time after one year, your ProMaster product fails under normal use, we invite you to return it to ProMaster for evaluation.

Made in China







[pro]master®

WWW.PROMASTER.COM | FAIRFIELD CT 06825